

SPICE thermal model

BUK6E2R0-30C

Symbol	Parameter	Conditions	Min	Typ	Max	Unit
$R_{th(j-mb)}$	thermal resistance from junction to mounting base		-	-	0.49	K/W

C_{th1}	9.100E-02 F
C_{th2}	1.600E-02 F
C_{th3}	4.002E-03 F
C_{th4}	1.023E-03 F
C_{th5}	2.617E-04 F
C_{th6}	6.690E-05 F
C_{th7}	1.711E-05 F
C_{th8}	4.374E-06 F
R_{th1}	3.290E-01 Ω
R_{th2}	1.210E-01 Ω
R_{th3}	3.000E-02 Ω
R_{th4}	7.379E-03 Ω
R_{th5}	1.822E-03 Ω
R_{th6}	4.499E-04 Ω
R_{th7}	1.111E-04 Ω
R_{th8}	2.744E-05 Ω

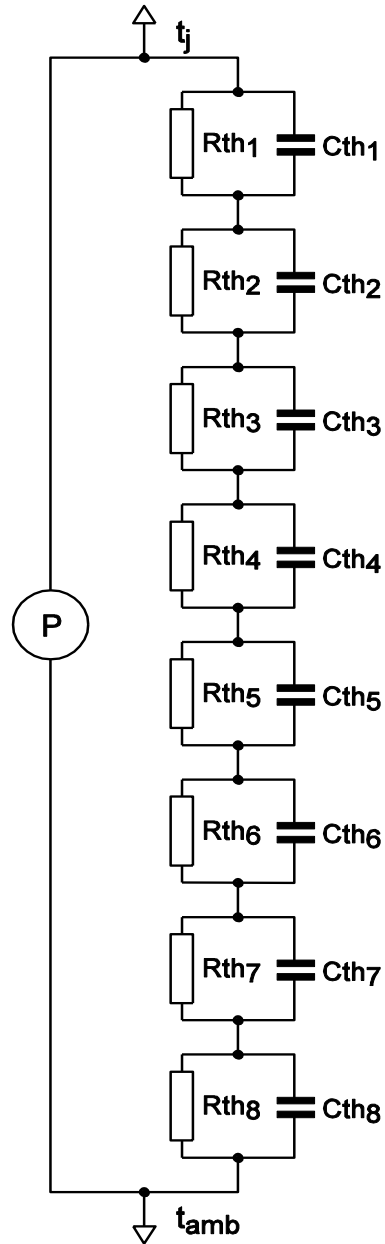

001aal768

Part: BUK6E2R0-30C
 Version: 1
 Date: 17-9-2010
 Rth: 0.49